

F-SERIES ANALOG JOYSTICK



CTI's OEM F-Series industrial joysticks use a non-contacting inductive sensor technology, providing superior reliability over potentiometer, hall-effect, or contacting based technologies. Potentiometer and contacting sensors inherently breakdown over time with usage, while hall-effect sensors change over time creating drifting issues. The inductive sensor design is free of those debilitating physical limitations, as well as immunity to changes in temperature or humidity. The inductive sensor only susceptibility is to extraneous high EMI/RFI signals which are mitigated by the use of a conductive boot and ferrite bead to provide an effective shield.

The NEMA 4 (IP66) sealing F-Series analog industrial joysticks are most suitable for critical applications requiring high durability (10M+ cycles), high availability (99.999% uptime), and/or high reliability (extreme operating temperatures, exposure to harsh climate conditions or solid and liquid contaminants). Its compact size minimizes below depth panel area by usage of an external analog PCB which provides a high precision proportional analog output voltage.

The modular sub-assembly design means that a tailored joystick can be rapidly and cost effectively manufactured in low volume. Manufacturing options offer protection against operation in extreme temperature ranges, rapid changes in temperature causing condensation or high humidity, protection against high vibration, EMI/RFI signals, and a separate autonomous signal is available as an open or short circuit safety indicator. The combination of these options allows for a varied high product ratio mix which meets industry standards specifications including aerospace, military, marine, medical, and transportation.

F1000-N2 STANDARD FEATURES

- High Precision proportional analog output voltage
- Low-Profile Analog Joystick Knob
- Single Axis or Two Axes (Simultaneous or Non-Simultaneous)
- External Analog PCB - Improves reliability and eliminates drifting or "in-service" recalibration issues.
- Deadband at Center (+/- 1° to 2°)
- Movement Spring Return (Friction Held - Special Order)
- Operating Temperature 0°C to 80°C (0°F to 176°F)
- Neoprene Boot - NEMA 4 (IP66) sealing - Operation in harsh environmental conditions
- Non-contacting inductive sensor technology allows high reliability (99.999%) and durability (10,000,000+ random deflections)
- Brass Threaded Inserts (#4-40 or 3mm) guarantees sealing rating without concern of breakage due to over torque

F-SERIES HANDLES / KNOBS

- NON-PUSHBUTTON N5 | N2 | N24 | N54
 PUSHBUTTON N3 | N33 | N63 | N34
 3 AXES N34 | N82 | N84

F-SERIES MANUFACTURING OPTIONS

A	Adapter Plate (Integrated PCB Option)
D	Operating Temperature Range -40°C to +80°C (Standard 0°C to +80°C)
Z	Conformal Coating of PCB (protects electronic components against condensation)
R	Silicone Conductive Boot (EMI/RFI Protection)
F	Ferrite Bead (EMI/RFI Protection - ONLY used if joystick is mounted in a metal enclosure)
1	Optical Neutral "Safety" Switch (Electrical indicator of an Open or Short Circuit typically used in Motion Control Applications)
G	Maximum Compression Spring (typically used in Mobile Applications)
E	No Deadband at Center (greater control via software algorithm is required)

*For complete ordering information please refer to [Technical Drawing 761734](#)

F1000-N2 TECHNICAL DRAWING

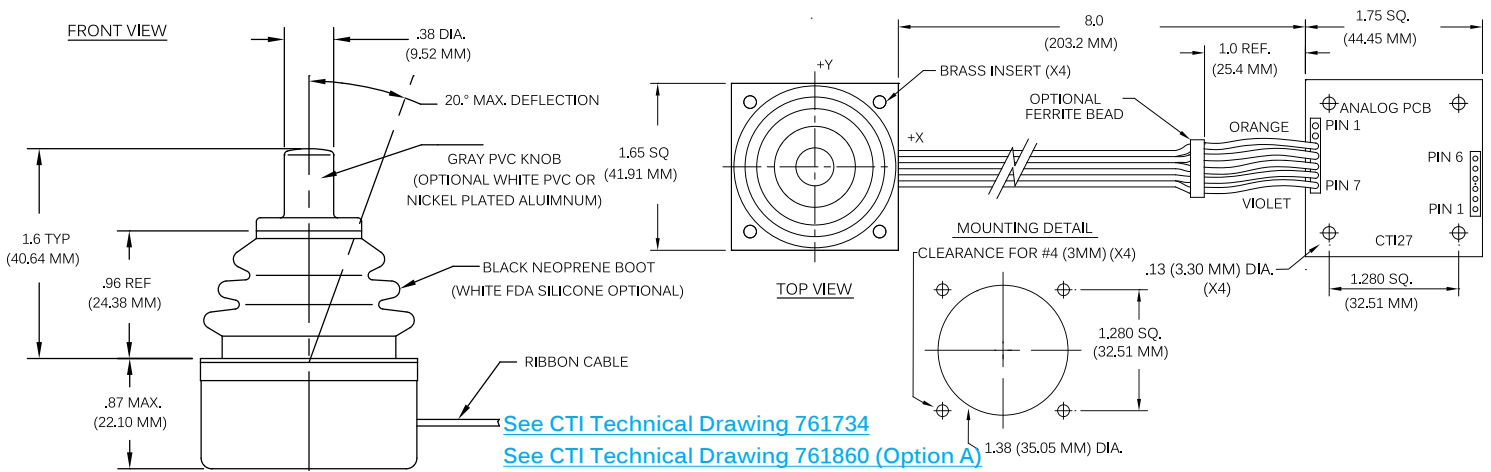

F-SERIES JOYSTICK PATENTS

U.S.A. PATENTS [4.825.157](#) | [5.376.946](#) | [5.532.476](#)



when reliability is critical™

F1000-N2

OEM ANALOG JOYSTICK

ELECTRICAL SPECIFICATION

Power Consumption	10mA @ 5VDC (typical)		25mA @ 24VDC (typical)				
Repeatability					> 1%		
Accuracy					> 1% Full Scale (typical) > 2% Full Scale (worst case)		
Option	Regulated Input Voltage (DC)	Min Deflection Output Voltage	Output Center Voltage	Max Deflection Output Voltage	Impedence (ohms)	Optical Neutral "Safety" Switch	Vref
0	+12	3	6	9	1k	N/A	Vref =6.0V (Vs=12.0V)
1	+5	1.25	2.5	3.75	1k	0V at Center, 5V off Center	Vref =2.5V (Vs=5.0V)
2	+/-5 (Dual Supplies)*	-5	0	5	1k	0V at Center, 5V off Center	Vref =5.0V (Vs=10.0V)*
3	+/-12 (Dual Supplies)	-10	0	10	10k	N/A	N/A
4	+5	0.5	2.5	4.5	1k	0V at Center, 5V off Center	Vref =2.5V (Vs=5.0V)
5	+5	0	2.5	5	1k	0V at Center, 5V off Center	Vref =2.5V (Vs=5.0V)
6	+/-10 (Dual Supplies)	-10	0	10	10k	N/A	N/A
*Optional single 10V supply alternative - contact factory for installation details							
Deadband (Default)	Center Voltage remains constant within 1° to 2° deflection of joystick.						
No Deadband (E Option)	Center Voltage will change within the 1° to 2° perimeter around center.						
Optical Neutral "Safety" Switch	Provides the Electronics Design Engineer with a "circuit safety or operations normal" signal, used to indicate an Open Circuit or Short Circuit. This optical indicator is totally separate, independent, and complementary to the Vx, Vy proportional output voltages. Joystick at center signal is 0V, off center signal is 5V.						
Vref (Virtual Reference Voltage at Center/Baseline)	Allows the Electronics Design Engineer some control over the ratiometric (proportional) output voltages Vx, Vy, Vz when a Voltage Source (Vs) has precision/tolerance ratio >0.01% or expected to vary slightly over time. Used as an Output Voltage, Vref is ½Vs. Taken as an Input Voltage (e.g. A PLC has a precise Reference Voltage) it pins the Center/Baseline Voltages X, Y, & Z to a known constant.						

MECHANICAL SPECIFICATION

N2 Knob Dimensions	Above Panel: 1.6" (40.64mm)		Below Panel: 0.87" (22.10mm)		Base: 1.65" SQ. (41.91mm SQ.)		
N2 Specifications	Knob Type	Non-Pushbutton	Axes	Single or Dual Axes	Sensor Technology	Inductive	
Life Expectancy	X & Y Axes			10,000,000 random deflections			
MTBF	Greater than 100,000 hours						
Movement	X & Y Axes (Simultaneous or Non-Simultaneous Movement)			Max +/- 20° travel			
Position/Placement	Spring Return (Standard)			Friction Held (Special Order)			
Operational Force	X & Y Breakout Force	140g (Standard)	Two (G Options)	X & Y Full Scale Force	235g (Standard)	Two (G Options)	
Shock	Peak Value	30-50g	Peak Duration	11ms	Waveform	Half Sine	
Vibration	Frequency / Displacement		5-25 Hz / 0.1"		25-55 Hz / 0.03"		

ENVIRONMENTAL SPECIFICATION

	Standard	Optional
Operating Temperature	0° to 80° C / 32° to 176° F (Standard)	-40° to 80° C / -40° to 176° F (D Option)
Storage Temperature	-40° to 80° C / -40° to 176° F	
Relative Humidity	Range 35-65%, 100% non-condensing	100% condensing (Z Option)
Sealing Rating	X & Y Axes: NEMA 4 (IP66)	

CONFORMANCE / CERTIFICATIONS / COMPLIANCE

subject to manufacturing options applied

U.S.A. Standards	U.S. FCC 47 CFR 15 Class A & B	RF Emissions Compliant 8Kv (Contact), 15Kv (Air)
	MIL-STD-461F	Radiated Emissions and Susceptibility Conformance
	MIL-STD-810G	Protection against humidity, fungus, and salt spray Conformance
	MIL-STD-901D	Protection against shock Conformance
	MIL-STD-167-1	Protection against vibration Conformance
	MIL-STD-1472G	Human Factors Conformance
	MIL-I-45208	Quality System Conformance
	IPC-A-610	Acceptability of Electronics Assemblies Certification
European Standards	"CE" Compliant	
	Restriction of Hazardous Substance (RoHS) Directive Compliant	
	Regulation on Registration, Evaluation, Authorisation and Restriction of Chemicals (REACH) Directive Compliant	
International Standards	IEC 61000-4-2 and EN61000-4-2	ESD 8Kv contact and 15Kv air Conformance
	IEC 61000-4-3 and EN61000-4-3	Radiated Emissions and Susceptibility Conformance
	IEC 61000-6-3 and EN61000-6-3	Electromagnetic Compatibility Conformance
	IEC 60601-1 and EN60601-1	Medical Device Design and Manufacture Conformance
	IEC 62353 and BS EN62353	Medical Device Recurrent Testing Conformance